

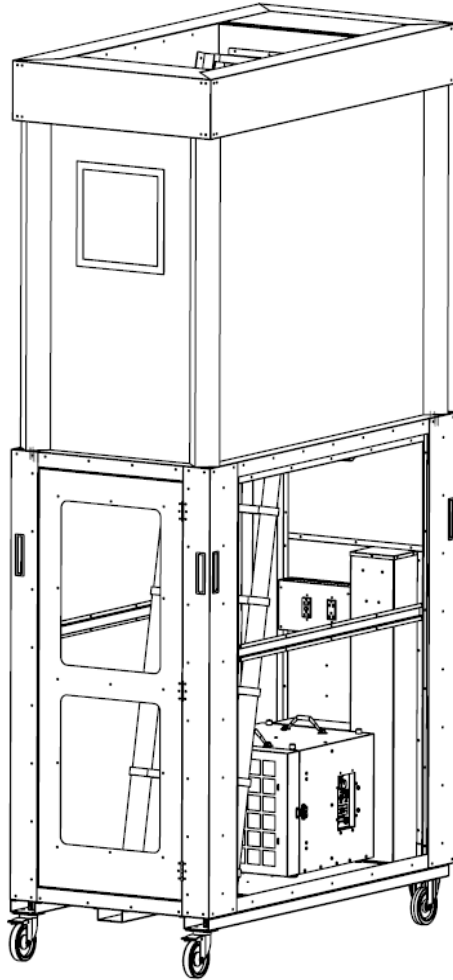

AIRE GUARDIAN® AG8000 Hard-sided Mobile Containment Unit



INSTRUCTION MANUAL

Covered by one of more of the following:

U.S. Patent No. 9,574,399

U.S. Patent No. 10,195,979

Canada Patent No. 2,895,016

Abatement Technologies

Abatement Technologies, Inc.

Georgia, USA

+1 800 634 9091

Abatement Technologies Limited

Ontario, Canada

+1 905 871 4720

www.abatement.com

READ AND SAVE THESE INSTRUCTIONS!

Note:

1. **Read and understand all operating instructions before using the AIRE GUARDIAN® AG8000.**
 2. **Save this manual for future reference.**
-

This manual provides important information on the features and usage of the AIRE GUARDIAN® AG8000 Hard-sided Mobile Containment Unit. These instructions must be carefully followed in order to assemble and use the components safely and correctly. If you have any questions regarding this system, please call Abatement Technologies® at +1 800 634 9091 (US) or +1 905 871 4720 (Canada) for assistance or to request a digital copy of this manual.

Table of Contents

Important Safety Instructions.....	1
General Information.....	3
Transporting Between Facilities	3
Feature Identification.....	4
Optional Accessories	7
Operating Instructions	8
Basic Operation	8
Suggested Operating Procedure.....	14
Care of the Unit.....	15
Aire Guardian® AG8000 Specifications	15
Certification Of Mobile Containment Units	17
Limited Warranty.....	17
Extension Ladder Warning and Instruction Labels.....	18
AG8000 Wiring Diagram	19

IMPORTANT SAFETY INSTRUCTIONS

 **Warning:** Failure to follow all instructions may result in serious personal injury or death!

 **Warning:** This mobile containment unit is made primarily of metal. Metal conducts electricity. Use extreme caution when using near electrical circuits, equipment, or other electrical conductors!

⚠ Warning: Do not use around exposed energized lines or equipment. Power to the lines in the area of work must be turned off and protected from being turned on with a lockout-tagout.

⚠ Warning: Do not use this unit near sparks, open flames, or other possible sources of ignition.

⚠ Warning: Do not enter unit without all four casters being locked and stable!

⚠ Warning: Pinch hazard! Do not use hands or fingers to unlock swivel casters or personal injuries such as severe pinching or cuts could result. Use work shoe to lock and unlock casters.

Do not leave cart unattended without locking all four casters.

All four casters must be locked before entering the AIRE GUARDIAN® AG8000.

The AIRE GUARDIAN® AG8000 is for use by one person only. Maximum load capacity is 900 pounds.

Use extreme caution when entering or exiting the AIRE GUARDIAN® AG8000.

Never move the unit while someone is inside! Always check to be certain no one is inside the unit before moving it.

Use only on level, dry surfaces. Do not use on slippery surfaces.

Do not put anything under the base or wheels of the AIRE GUARDIAN® AG8000.

Do not use in front of doors that could unexpectedly be opened into the AIRE GUARDIAN® AG8000.

Only use where allowed under federal, provincial, state, local, and facility regulations.

Inspect for damage before each use. Be sure all parts are present and in working order.

Abatement Technologies strongly urges all users of the AIRE GUARDIAN® AG8000 to follow the most recent guidelines and/or standards published by the Occupational Safety and Health Administration, Environmental Protection Agency, and all other federal, state, provincial, local and employer regulations. In addition, the proper personal protective equipment should be used at all times.

Before using, learn and understand your facility's Infection Control Risk Assessment (ICRA). Follow all Centers for Disease Control (CDC) and Association for Professionals in Infection Control and Epidemiology (APIC) recommendations.

GENERAL INFORMATION

The AIRE GUARDIAN® AG8000 is a mobile containment unit designed to capture and contain particulate during ceiling access work on ceiling heights up to 10'-2". Ceiling heights up to 12'-2" can be reached with the Extension (P/N: AG8000-EXT24, sold separately). Additionally, a Side Access Panel (P/N: AG8000-SA, sold separately) can be installed to provide containment while doing wall access projects. Numerous user-friendly features help maintain superior levels of patient protection, worker safety, and productivity unmatched by any other hard sided cart.

The AG8000 is designed to comply with ICRA requirements for projects requiring ceiling access and limited wall access. The unit and its accessories can be used to meet various mitigation activities which are required by the ASHE Infection Control Risk Assessment 2.0 Matrix of Precautions for Construction, Renovation and Operations and other regulating documents. These activities include, but are not limited to

- Airborne dust dispersion prevention.
- Neutral to negative pressurization.
- Barriers that extend to the ceiling.
- Indoor air exhaust that is HEPA filtered.
- An impermeable temporary containment vessel.

The AIRE GUARDIAN® AG8000 is designed to be used with the provided extension ladder only and should not be used with any other ladder. Read all instructions within this manual as well as all danger, caution, and instruction labels affixed to the ladder.

This unit should be used in conjunction with an air scrubber in order to meet ICRA requirements where required. The AG8000 was designed to accept the PAS750 Portable Air Scrubber (sold separately) inside the unit, but has the flexibility to have an external air scrubber ducted to the unit's port (P/N: AG8000CADK, sold separately).

This manual provides instructions on how to use the features of the AIRE GUARDIAN® AG8000, however, the procedure and/or order of operations in which it is used should be determined by the healthcare facility's ICRA plan. **Any procedural information contained within this manual is to be taken as a suggestion only to help the user understand some of the design intent of the unit.**

TRANSPORTING BETWEEN FACILITIES



The AG8000 should be secured to ensure that the unit does not roll during transport and transported in its normal position (resting on its casters). If extremely poor road conditions exist, or excessive shock and vibration are expected, take precautionary measures by padding the unit to provide impact absorption during transport.

Additionally, secure the ladder to the floor with the included ratchet strap (P/N: HARDWRE209).

FEATURE IDENTIFICATION

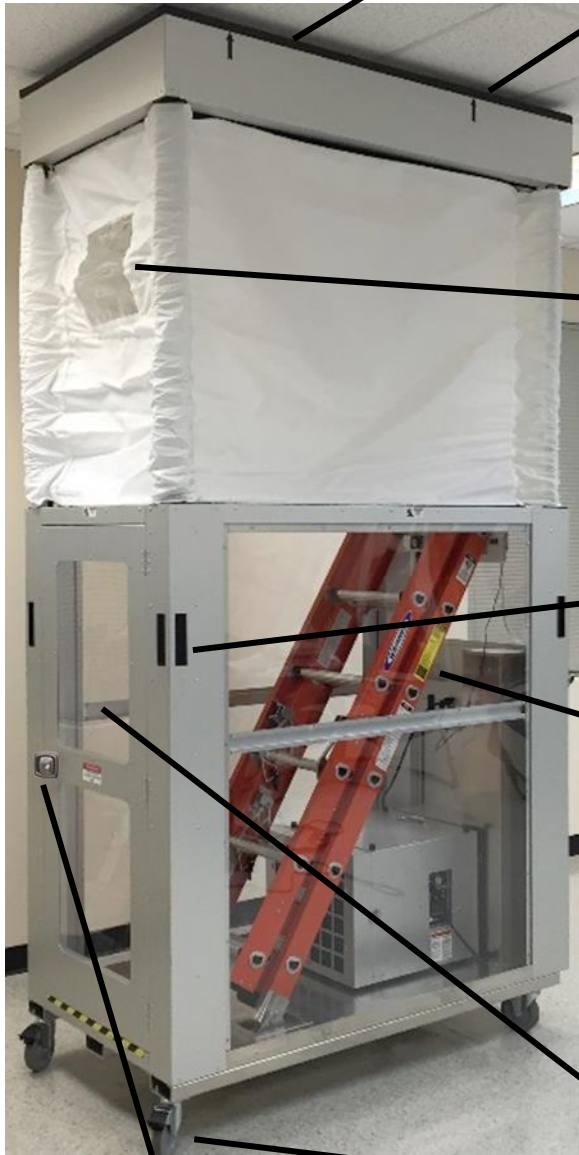

- A. Foam gasket. The 1" thick foam gasket provides a seal against the ceiling when the header is raised to the ceiling.
- B. Header opening markers. In order to help align the unit, there are arrow marks on the outside of the header that indicate where the opening inside the unit begins and ends. Position the arrow furthest away from the door to align with the ceiling grid.
- C. 12" x 12" window & pass-thru. A total of two clear windows allow visibility into and out of the fabric enclosure. The windows are attached via hook and loop on three sides, enabling it to be opened and act as pass-throughs for items such as pipe or conduit.
- D. Handles. A total of 8 handles are located at the corners of the mobile containment cart to assist in transport.
- E. Fiberglass extension ladder. The AIRE GUARDIAN® AG8000 was designed around the included fiberglass extension ladder and should only be used with this ladder. **Read all warning and instruction labels located on the ladder as well as the instructions within this manual to properly operate the ladder.**
- F. Door. Door opening of 54.5" H x 22" W.
- G. Casters. This unit has 4 lockable swivel casters.



Lockable recessed handle. The lockable door helps protect tools and equipment within the mobile containment cart when not in use.

Note: To reduce the risk being locked out of the mobile cart, Abatement Technologies suggests making a copy of the key and storing the master in a secure place.



- H. Header. The manual refers to this part as the header, which is raised and lowered using the provided hand crank or a power drill with clutch (not provided).
- I. Fabric enclosure. The fabric enclosure provides a flexible barrier that can accommodate the raising and lowering of the header. This enclosure is constrained by the telescoping members, which keeps it from encroaching into the work space under negative pressure. It is removable and washable (replacement P/N: AG8000ENC-FR)
- J. Raising/lower mechanism. The raising/lowering mechanism adjusts the height of the header. This can be operated by the provided hand crank or a power drill with clutch (not included).
- K. External receptacles. The unit comes with a 3-prong male receptacle for connection to a 120V 60Hz power source that is used to power the female receptacles on the unit. There is also a receptacle that is designed specifically for use with a PAS750 Portable Air Scrubber unit (this receptacle is connected to the remote variable speed control inside the cart, DO NOT use with any other device). The other receptacle is a standard receptacle. A maximum of 15 amps can be used with AG8000's electrical system.
- L. Cord wrap. Store an extension cord around the cord wrap for convenience (extension cord not included).
- M. Intake/exhaust port. Acts as an exhaust port when a PAS750 Portable Air Scrubber unit is located inside the cart. The AG8000CADK Caddy and Connection Kit (not included) can be attached on the outside for locating a PAS750 or PRED750 externally.



- N. Ladder bracket. The ladder bracket is attached to the header and accepts the top of the provided extension ladder.
- O. Ladder straps. A ladder strap is located on each side of the ladder bracket to further secure the provided extension ladder.
- P. Pressure monitor mounting bracket. An Abatement Technologies' RPM series pressure monitor can be installed inside the unit on this mounting bracket. This mounting bracket is included with all units (pressure monitor sold separately).
- Q. Remote variable speed control. There are designated electrical sockets on the inside and the outside of the unit that are wired to the remote variable speed control. Plugging a PAS750 Portable Air Scrubber into these sockets allows those units to be controlled with the remote variable speed knob that can be accessed while standing on the extension ladder.
- R. Internal GFCI receptacles. One receptacle is designated for a PAS750 Portable Air Scrubber to allow remote variable speed control (Q). The remaining receptacles can be used for other devices that run off of 110-120VAC. A maximum of 15 amps can be used with AG8000's electrical system.
- S. PAS750 Portable Air Scrubber (not included). The optional PAS750 Portable Air Scrubber unit is recommended in order to create negative pressure for particulate containment.
- T. Recessed ladder pockets. There are two recessed pockets in the floor that secure the extension ladder's feet to keep the ladder from sliding and also to ensure that the proper angle is kept.
- U. Top cover (not shown). The top cover closes the opening in the header to provide full containment during transport and during usage before ceiling tiles are removed (replacement P/N: AG8000TOP-FR).

OPTIONAL ACCESSORIES



An optional Side Access Panel can be purchased for wall access projects (P/N: AG8000-SA). Once installed, the Side Access Panel and the original clear polycarbonate panel are interchangeable.



An optional Extension can be purchased to reach ceiling heights of 12'-2" (P/N: AG8000-EXT24). Additionally, it provides an increased area of ceiling access.

OPERATING INSTRUCTIONS

BASIC OPERATION

Raising and lowering the header

The AG8000 uses a mechanical system to raise and lower the entire header at a single operating point which is located on the back of the unit. Since this is a mechanical system, electricity is not required for this operation. There are two ways to operate this mechanism: (1) with the hand crank attachment (P/N: HARDWRE161) that is provided with the unit or (2) with a power drill with clutch (not included). For the power drill option, a bit for the drill is provided with the unit (3/8" socket adapter with a 5/8" socket). **It is highly recommended that the power drill has a clutch setting to help prevent over extending the header into the ceiling** (use the lowest clutch setting that is able to raise the header to the ceiling).



Turn hand crank clockwise to raise the header. Turn hand crank counter-clockwise to lower the header.



Alternatively, a power drill can be used to quickly and easily raise and lower the header.

⚠ Warning: Do not overextend the header into the ceiling! This may cause damage to the ceiling and/or the unit. Stop raising the header when the foam seal on the header touches the ceiling.

⚠ Warning: Do not allow the header to collide with any devices or fixtures installed in the ceiling or walls.

⚠ Warning: Be sure the ladder is retracted from the ladder bracket before lowering the header!

Locking the casters



To lock the casters, push down on the pedal with work shoe.

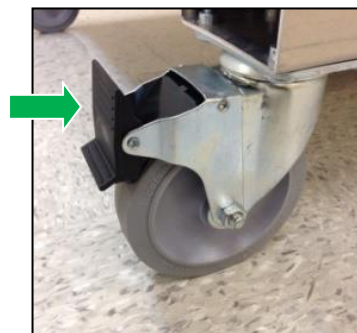

To unlock the casters, push the pedal towards the wheel with work shoe.

⚠ Warning: Pinch hazard! Do not use hands or fingers to unlock swivel casters or personal injuries such as severe pinching or cuts could result. Use work shoe to lock and unlock casters.

Supplying Power to the Unit

Power needs to be supplied to the unit in order for any of the electrical outlets to be functional, including the powering of the PAS750, if applicable. Note that the raising and lowering of the header does not require electricity as it is operated by a mechanical mechanism.



Power must be supplied to the AG8000 in order for any of the outlets to be operational. Plug the female end of an extension cord into the POWER SUPPLY outlet located on the back side of the unit and the male end into a 110V-120V, 60Hz, single phase outlet.



The AG8000 comes equipped with a power cord wrap that is located below the POWER SUPPLY outlet (**extension cord not included with unit, P/N: AG8000CORD**).

Using the fiberglass extension ladder within the AG8000

⚠ Important: Be sure to read and understand all warning and instruction labels located on the ladder before using the ladder.

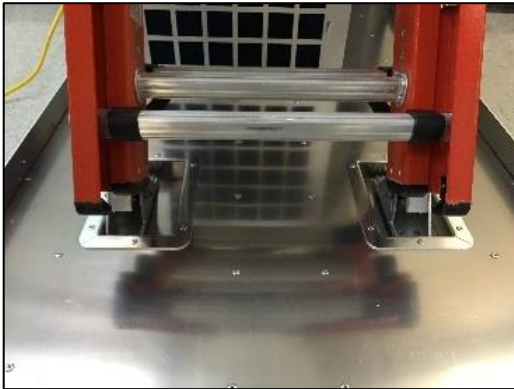

Place the feet of the ladder into the recessed pockets in the floor. Unbuckle the strap on the left side of the ladder that secures the three sections of the ladder together.



After raising the header to the ceiling, the ladder can be extended and placed against the ladder bracket. Use the hook and loop straps on each side of the ladder bracket to secure the ladder.



After the fabric top is unzipped and the ceiling tile is removed, the ladder can be extended above the ceiling, if necessary.

⚠ Important: The ladder must be placed within the recesses in the floor to secure the feet of the ladder and to maintain the minimum 75° angle required per OSHA requirements.

Opening and closing the top cover



The top cover has a zipper down each long side and is secured by hook and loop on the short side near the ladder.



Unzip the zippers on each side and detach the hook and loop on the short side near the ladder to open the top cover.



Roll up the top cover and place it in the cove in the header that is located opposite of the ladder.

Using the pass-through



Two 12" x 12" windows located in the fabric enclosure also act as a pass-through for conduit or other materials that need to be fed in from the outside of the mobile containment unit. Each is secured by hook and loop along the top and side edges and opens from the inside.

Using the remote variable speed control

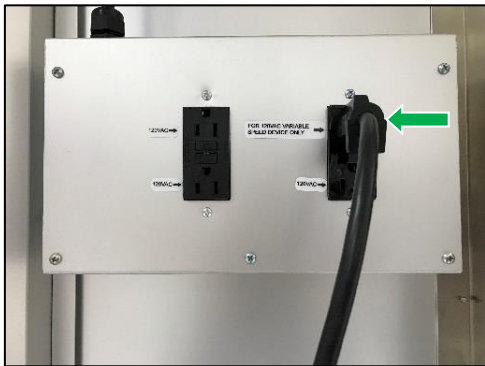

If the PAS750 unit is located inside the AG8000, plug the unit into the outlet labeled **"FOR 120VAC VARIABLE SPEED DEVICE ONLY"** as shown in the picture above.



If the PAS750 or PRED750 unit is located external to the AG8000, ensure it is plugged into the outlet labeled **"FOR 120VAC VARIABLE SPEED DEVICE ONLY"** as shown in the picture above.



Set the PAS750 to the highest setting on the unit's variable speed control knob.



The PAS750 is now ready to be controlled with the remote variable speed control.

⚠ Warning: Only use Abatement Technologies Portable Air Scrubber units with the variable speed control. Other units may not be compatible with the variable speed control and can result in fire, electrical shock, or personal injuries.

Transporting and positioning the AG8000 underneath ceiling tiles



Transport the AG8000 in the fully collapsed position and use the handles located at the corners of the unit to move the mobile containment unit.



Position the mobile containment unit in the approximate location where ceiling access is required.



Raise the header within a few inches of the ceiling, ensuring that the unit can still be moved without crashing into any objects.

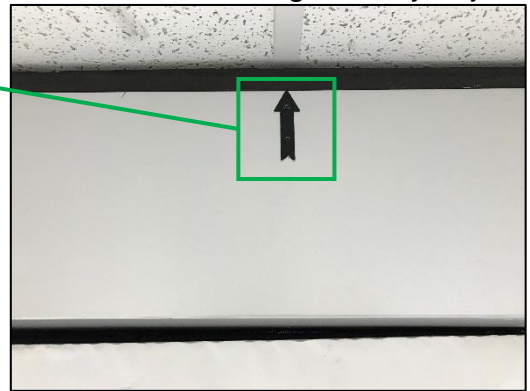
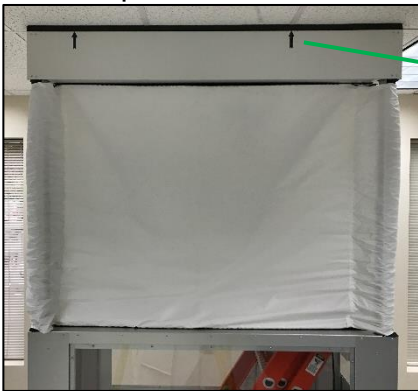

After raising the header close to the ceiling, fine tune the positioning by aligning the arrow marker closest to the back of the unit with the ceiling grid. After adjusting the position as needed, raise the header until it seals against the ceiling. Be sure to lock the casters before entering the unit.

⚠ Warning: Watch out for devices and fixtures installed in the ceiling and on the wall while transporting the AG8000. Colliding with any devices or fixtures can cause damage to the object it hits as well as damage the mobile containment unit.

Removing the fabric enclosure and top cover



Both the top cover and the fabric enclosure are fastened to the mobile containment unit via hook and loop. To remove the top cover, simply separate the hook and loop along the perimeter of the top cover. To remove the fabric enclosure, detach the hook from the loop from each of the four telescoping members as shown above. Then separate the hook and loop along the top perimeter and then the bottom perimeter.

Installing an RPM series pressure monitor



Locate the pressure monitor mounting bracket on the inside back wall of the AG8000.



Remove the faceplate from the RPM series pressure monitor by unscrewing the two small screws on the sides of the pressure monitor. Connect the reducing elbow to the “COM” port of the monitor and attach tubing to the other side of the elbow. Plug the power connector into the terminal as shown. Hang the monitor on the lower set of screws on the mounting bracket.



Plug the tubing into the barb located in the polycarbonate panel of the back wall. Reattached the faceplate to the monitor by tightening the two screws on the sides. Plug the power adapter into one of the standard 120V receptacles inside the AG8000.

SUGGESTED OPERATING PROCEDURE

The following procedure is a general guideline that provides an order of operations intended to contain particulate within the AG8000 mobile containment unit. Review your healthcare facility's ICRA plan and use this cart accordingly.

1. Ensure the unit is decontaminated before each use and test the air scrubber to ensure that it is working properly and that the filters do not need to be changed.
Note: There are two places that control the speed of the air scrubber unit: a knob directly on the portable air scrubber unit, and a remote knob located on the wall opposite of the door. The setting on the scrubber unit should be kept on the highest setting and the speed adjustments should be made on the remote variable speed control knob.
Warning: If using an air scrubber that is not manufactured by Abatement Technologies, do not use the remote variable speed control in conjunction with the air scrubber. Abatement Technologies air scrubbers have been tested to work with the variable speed control; other units may not be compatible.
2. Seal the unit completely before moving the unit throughout the healthcare facility.
 - a. Make sure the top cover is in place, zipped up, and that the hook is engaged to the loop in all places.
 - b. Make sure the soft sleeve is installed properly and that the pass-through windows are closed.
 - c. Make sure the door to the unit is closed.
3. Position the unit in the approximate location under the ceiling tiles that will be accessed.
4. Raise the unit using the raising mechanism with either the provided hand crank or a power drill within a few inches of the ceiling.
Warning: Be sure that the upper header will not crash into any device installed in the ceiling, such as sprinkler heads, sensors, etc. If using a power drill, be sure that the header is not over extended as this can damage the ceiling grid and/or the unit.
5. Using the arrow markers on the sides of the header, fine tune the position of the cart by aligning the markers with the ceiling grid.
6. Carefully raise the unit until the ceiling gasket seals against the ceiling. Again, be sure not to over extend the header such that the ceiling grid is damaged.
7. Lock all four of the casters by pressing the pedals on the casters down with your work shoe.
8. Supply power to the unit by plugging a power cord into the power supply outlet in the cart and into an outlet in the facility. Open the door and enter the unit. Be sure to close the door before beginning any work inside.
9. Place the feet of the extension ladder into the recessed pockets in the floor. Extend the ladder and rest it against the ladder bracket that is attached to the header.
10. Climb up the ladder and strap the ladder into place using the hook and loop straps located on the ladder bracket. Then, open the top cover by undoing the hook and loop on the short edge of the cover near the top of the ladder. Then, unzip the two zippers along the two long sides. Roll up the top cover and insert it into the top cover pocket.
11. Remove the ceiling tile. The extension ladder may now be raised into the ceiling if necessary to permit higher access into the ceiling.
12. Adjust the speed on the portable air scrubber as necessary using the remote variable speed adjustment knob and then perform the required work in the ceiling space.

13. When finished with the ceiling work, replace the ceiling tile and close the top cover by zipping up the two zippers and engaging the hook and loop on the short edge near the ladder.
14. Undo the hook and loop straps that secured the top of the ladder and then fully collapse the ladder.
15. Before exiting the unit, be sure to decontaminate yourself and the inside of the mobile containment cart using a HEPA filter vacuum.
16. Completely lower top header of the unit with the raising/lowering mechanism with either the provided hand crank or a power drill.
17. Unplug the power supply cord and wrap the cord around the cord wrap, if necessary.
18. Unlock all four of the casters by lifting the pedal on the casters up with your work shoe.
19. Move the unit to the next desired location, being careful to avoid any contact with signs or devices mounted on the walls or ceiling.
20. Repeat procedure starting from step 5, as needed.

CARE OF THE UNIT

- Clean with a mild water based cleaner or soap and water. Do not use hydrocarbon based cleaners.
- Do not place items on the vinyl enclosure.
- Do not subject the vinyl enclosure to sharp or abrasive objects.
- Be sure all metal components are properly secured during transport and in storage so they cannot fall and cause personal injury or property damage.
- Do not expose the vinyl enclosure to high heat.

AIRE GUARDIAN® AG8000 SPECIFICATIONS

FEATURE	SPECIFICATION
Weight with ladder	325 lbs (147.4 kg) (air scrubber and pressure monitor not included)
Maximum working ceiling height	10'-2" [312 cm]
Unit Height, Fully Collapsed	6'-5.5" [196 cm]
Unit Length x Width	62" L x 32" W [157.5 cm L x 81.3 cm W]
Header opening dimensions	36" L x 22" W [91.4 cm L x 55.9 cm W]
Door	54.5" H x 22" W [138.5 cm H x 56 cm W] door opening; lockable handle
Hardside wall material	Clear polycarbonate provides visibility and allows light into the unit.
Hardside wall material UL94 flammability rating	V0
Fabric enclosure	Fabric enclosure is removable and secured by hook and loop; includes two 12"x12" clear windows that each acts as a pass-through (window secured by hook and loop) (P/N: AG8000ENC-FR).

Top fabric	Top fabric is included with unit and secured by hook and loop (P/N: AG8000TOP-FR).
Fabric fire retardant standard	ASTM-E84/NFPA701
Ladder	16' three-section fiberglass extension ladder with 300 lbs weight capacity (P/N: LADDER03).
Ladder weight	40.5 lbs (18.4 kg)
Exterior finish	Anodized aluminum
Header raising/lowering	Mechanical system raises/lowers entire header with the provided hand crank or a power drill (not included with unit); 5/8" socket connection.
Casters	4 ea swivel, lockable, non-marking rubber casters.
Pressure monitor mount	Bracket and tubing port built into unit (RPM series pressure monitor sold separately).
Receptacles	<p>External receptacles located on back of unit:</p> <ul style="list-style-type: none"> • 1 ea. three prong male receptacle to connect power (power cord not included) • 1 ea. receptacle for general use • 1 ea. receptacle controlled by remote variable speed knob located inside the unit <p>Internal receptacles:</p> <ul style="list-style-type: none"> • 3 ea. receptacles for general use • 1 ea. receptacle controlled by remote variable speed knob <p>All receptacles rated 15 A; entire circuit rated 15 A.</p>
Scrubber speed control	Remote variable speed control knob located inside unit allows for easy access control of an air scrubber (scrubber sold separately).
Scrubber compatibility	Unit is designed to accept the PAS750 air scrubber inside the unit; a PAS750 or PRED750 scrubber can be located external to the AG8000.
Foam Gasket on Header	1" wide x 1" tall gasket around header perimeter to seal against ceiling.
Exhaust port	10" diameter exhaust grille located on back of unit.
Caddy cart	Optional caddy cart assembly that attaches to AG8000 is available for locating the scrubber external to the unit (P/N: AG8000CADK).
Side Access	Optional Side Access Panel (P/N: AG8000-SA)
Storage Cover	Optional storage cover (P/N: AG8000SC)
Extension	Optional extension for ceilings up to 12'-2" and for increased header nominal opening to 60" L x 46" W (P/N: AG8000-EXT24)
Patents	Covered by one of more of the following: U.S. Patent No. 9,574,399 U.S. Patent No. 10,195,979 Canada Patent No. 2,895,016

CERTIFICATION OF MOBILE CONTAINMENT UNITS

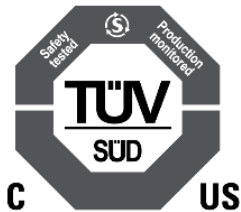

Abatement Technologies AG8000 mobile containment control panels are independently tested and certified to the relevant safety requirements by TÜV SÜD.

TÜV SÜD is accredited by the U.S. Occupational Safety and Health Administration (OSHA) as a Nationally Recognized Testing Laboratory (NRTL).

LIMITED WARRANTY

Abatement Technologies (AT) warrants that goods sold to the original user shall be free from defects in material and workmanship for a period of 1 year, except such as are commercially acceptable. **AT does not warrant that the goods sold are merchantable or fit for any particular purpose. AT makes no warranties other than as stated in this paragraph. All other warranties, guaranties, or representations, express or implied, by operation of law or otherwise, are expressly disclaimed.** Goods found by AT to be defective or not to conform to specification shall upon return be replaced or repaired by AT without any additional charges, or, at AT's option, AT may refund the purchase price of such goods. AT will pay return transportation charges on returned goods not exceeding the transportation charges applicable to shipment from original destination unless the returned goods are free from defect and conform to specifications. Returned goods which are found by AT to be free from defect and to conform to specifications shall be held for Purchaser's shipping instructions, which instructions Purchaser shall furnish promptly upon request. **AT's liability shall in no event extend beyond replacement, repair or refund of the purchase price and AT shall not be liable under any circumstances for special, contingent or consequential damages, nor for loss, damages, or expenses directly or indirectly arising from the use of the goods, including without limitation, warehousing, labor, handling and service charges, die, equipment, or machine breakage, nor for costs, lost profits or loss of good will. The use of substitute, non-AT parts, in any AT product, voids all warranties and performance claims. The remedies set forth herein are exclusive.**

For warranty information and assistance contact Abatement Technologies' Customer Service Department at +1 800 634 9091 (U.S.) or +1 905 871 4720 (Canada).

EXTENSION LADDER WARNING AND INSTRUCTION LABELS

CAUTION
MISE EN GARDE

SET UP LADDER PROPERLY TO REDUCE SLIP AND OVERLOAD HAZARDS. FOLLOW THESE INSTRUCTIONS.

INSTALLER L'ÉCHELLE COMME IL FAUT AFIN DE DIMINUER LES RISQUES DE GLISSEMENT ET DE SURCHARGE. SUIVEZ LES PRÉSENTES DIRECTIVES.

SECURE LOCKS
FERMEZ LES VERROUILLAGES

- PLACE TOES AGAINST BOTTOM OF LADDER SIDERAILS.
- STAND ERECT.
- EXTEND ARMS STRAIGHT OUT.
- PALMS OF HANDS SHOULD TOUCH TOP OF RUNG AT SHOULDER LEVEL.

1. PLACEZ LE BOUT DES PIEDS CONTRE LE BAS DES MONTANTS DE L'ÉCHELLE.

2. TENEZ-VOUS BIEN DROIT.

3. ÉTENEZ LES BRAS VERS L'AVANT.

4. VOS ÉTES SENSÉ POUVOIR TOUCHER LE DESSUS DE L'ÉCHELON SITUÉ À HAUTEUR D'ÉPAULE AVEC LA PAUME DES MAINS.

1. DO NOT OVER-REACH. KEEP BODY CENTERED BETWEEN SIDE RAILS.

2. EXTEND LADDER THREE (3) FEET ABOVE ROOF FOR ACCESS.

1. NE Tendez PAS LES BRAS TROP LOIN. GARDEZ LE CORPS BIEN CENTRÉ ENTRE LES MONTANTS DE L'ÉCHELLE.

2. ÉTENEZ L'ÉCHELLE DE TROIS (3) BARREAUX AU-DESSUS DU TOIT POUR Y ACCÉDER.

P/N 104232-02 Rev B 1/12

FIBERGLASS SINGLE AND EXTENSION LADDER SAFETY INSTRUCTIONS

WARNING: Failure to follow all instructions may result in serious injury.

- READ ALL LABELS!
- Only use ladder if you are in good physical condition.
- Ladder designed to support weight of one person and materials. Maximum weight not to exceed duty rating of ladder (see other labels).

INSPECTION

- Inspect for damaged or missing parts before each use.
- Never use a ladder with missing or damaged parts.
- Check all parts for good condition. Lightly lubricate moving parts occasionally.
- Never repair a damaged ladder without permission from manufacturer.
- Destroy ladder if exposed to excessive heat or any corrosive agent.

PROPER SET-UP

- DANGER METAL CONDUCTS ELECTRICITY!** Be careful when using near electricity as shock or electrocution can occur.
- Place ladder feet on firm level ground and check that all four ends of the ladder are firmly supported to prevent excessive movements.
- Set ladder at proper angle by placing your toes against the bottom of the ladder. Extend arms straight out. When palms of hands contact top of rung (about shoulder level), ladder is at approximately the proper angle. (See other labels). Use at proper angle.
- Never place anything under or attach anything to a ladder to gain height or to adjust for uneven surfaces, other than a ladder leveler approved by the manufacturer of this ladder.
- When use is required on a slippery surface, secure ladder from excessive movement.
- The use of ladders on drop cloths may present a sliding hazard.
- Do not use ladder in front of unlocked doors.
- Extend only from ground: When using for access to roof, extend ladder top 3 feet above roof edge.

PROPER CLIMBING AND USE

- DO NOT OVER-REACH.** You may lose your balance and/or tip the ladder. Keep center of waistline between side rails and use caution whether climbing, pushing, or pulling anything while on the ladder.
- Always face ladder and maintain a firm grip while on it.
- Never walk, bounce or move a ladder while climbing or standing on it.
- SECURELY ENGAGE LADDER LOCKS BEFORE CLIMBING.**
- Never climb or stand higher than 3 feet from the top of the ladder.
- Never use as a platform, plank, or brace.
- When possible, have someone hold the ladder.
- Windy conditions require extra caution.
- Do not use any components not supplied or approved by the manufacturer of this ladder.
- Never use ladder ladders on Type II or Type III extension ladder (see other labels).

PROPER CARE AND STORAGE

- Always keep ladder clean of all foreign materials.
- Never store material on ladder.
- Properly support and restrain ladder in transit or storage. Wear damage from transit vibration may weaken ladder.
- For additional care, use and safety instructions contact your employer, dealer or the manufacturer, or see ANSI A14 Standards (see other labels).

Manufacturer can be contacted at 888-229-7727.

ALWAYS USE LADDER AS DESCRIBED ABOVE. NEVER MISUSE OR ABUSE A LADDER.

© 2008 Werner Co. Rev 1.3/08 P/N 56771-05

DANGER

LOCKED FULLY HOOKED OVER BASE RUNG
VERROUILLÉ BIEN ACCROCHÉ SUR UN BARREAU DE LA BASE

MIDDLE SECTION SECTION INTERMÉDIAIRE

BASE

SAFETY SHOE
STABILISATEUR DE SÉCURITÉ

Always be sure the locks are fully engaged and the fly is on top of the base as pictured above before climbing.

Assurez-vous toujours que les verrouillages sont complètement engagés et que la section mobile est en haut de la base comme c'est illustré avant de monter.

Make sure shoes are positioned as shown above when used on firm, non-slippery surfaces.

Assurez-vous que les patins sont positionnés comme montré par-dessus quand ils sont utilisés sur des surfaces fermes non-glissantes.

Use spur plate on penetrable surfaces. Utilisez une plaque à éperon sur des surfaces pénétrables.

Lift ladder and rotate shoe as shown.

Shoe will catch in the locking notch to hold shoe vertical. Soulevez l'échelle et tournez-la, tel qu'illustré. Le stabilisateur se coince dans le bec pour maintenir le stabilisateur en position verticale.

To disengage from spur plate position, unweight ladder and pull shoe towards you. Pour désenclencher de la position crampons, allégez l'échelle et tirez le stabilisateur vers vous.

©2012 Werner Co. P/N 104506-02 Rev B 9/12

CAUTION / ATTENTION

TO PREVENT DAMAGE TO LADDER LOCKS, EXTEND AND RETRACT THIS LADDER BY FOLLOWING THIS PROCEDURE

POUR ÉVITER DES DOMMAGES AUX VERROUILLAGES D'ÉCHELLE, ÉTENEZ ET RETRACTEZ L'ÉCHELLE EN SUIVANT CETTE PROCÉDURE

TO EXTEND THE LADDER POUR ÉTIRER L'ÉCHELLE

STEP 1
Adjust upper fly section to desired height
Upper fly section must be extended at least two rungs before middle section can be extended.

ÉTAPE 1
Ajustez la section haute mobile à la hauteur voulue
Cette section haute mobile doit être étirée au moins d'un barreau avant que la section intermédiaire puisse être étendue.

STEP 2
Adjust middle section to desired height
Ajustez la section intermédiaire à la hauteur voulue.

TO RETRACT THE LADDER POUR RETRACTER L'ÉCHELLE

Step 1 First lower middle section slowly into fully retracted position.

Étape 1 Commencez par abaisser lentement la section intermédiaire en position complètement rétractée.

Étape 2 Puis, abaissez la section haute mobile en position complètement rétractée.

TO DESCEND THE LADDER POUR DESCENDRE L'ÉCHELLE

To safely descend the ladder, always stagger sections as shown.

Never attempt to step directly from the upper fly section to bottom base section.

Pour descendre l'échelle en toute sécurité, décaler les sections comme indiqué.

N'essayez jamais d'intervenir directement à partir de la section supérieure mobile de l'échelle à la section base de fond.

© 2012 Werner Co. Rev C 9/12 P/N 104507-03

PORTABLE EXTENSION LADDER
ÉCHELLE À COULISSANTE PORTATIVE

Place ladder on firm level surface at a slope of 1 in 4. Make sure all four ends are secure against movement.

Placez l'échelle sur une surface ferme et de niveau, avec une inclinaison de 1 à 4. S'assurez que les quatre extrémités ne peuvent se déplacer.

Check ladder before each use. Make sure ladder locks are engaged. The use of damaged ladders can be dangerous.

Vérifier consciencieusement l'échelle avant chaque usage. S'assurer que les verrous sont engagés. L'utilisation d'une échelle endommagée peut être dangereuse.

DO NOT overreach. Keep belt buckle between side rails.

Ne pas tendre le bras outre mesure. Maintenir le crochet du ceinturon entre les deux montants.

DO NOT mis-use. Ladders are for one person only.

Ne pas employer l'échelle pour d'autres usages. Une échelle est conçue pour une personne seulement.

Avoid contact with electrical wiring or devices.

Éviter tout contact avec des câbles ou autres éléments électriques.

© 2008 Werner Co. GV P/N100087-05 Rev B 5/08

WERNER

★ ★ ★ ★ ★

300 lbs. / 136 kg

LOAD CAPACITY Includes User and Materials

CAPACITÉ Incluant l'utilisateur et les matériaux

GRADE 1 CONSTRUCTION AND INDUSTRIAL

CATÉGORIE 1 CONSTRUCTION ET INDUSTRIE

HEAVY LOAD RATING

GRANDE CAPACITÉ DE CHARGE

TYPE IA DUTY RATING

CLASSE DE RENDEMENT DE TYPE IA

18'
5.49m

Ladder Height
Hauteur de l'échelle

Equivalent working height: 14' 16" (See section label)
Équivalent de des section: 4m 30" (Voir étiquette de section)

Maximum Reach*
15.57m

Portée maximale*

Highest Standing Level
9'5"
2.87m

Le plus haut niveau vertical

Model Number
D6216-3CA

Numéro de modèle

Mk 1

* Assumes a 5'6" person with a vertical 12" reach
* Supposer une personne de 1.68m avec une portée verticale de 0.30m

Non-Conductive Fiberglass Side Rails
Longerons latéraux non conducteurs en fibres de verre GV

100527

OSHA
SAFETY AND HEALTH ADMINISTRATION
U.S. DEPARTMENT OF LABOR

ANSI A14.5

P/N 100527-129 Rev Q 9/12
©2012 Werner Co. Greenville, PA 16125
Made in Mexico
Fabriqué au Mexique.

0 51751 11382 2

AG8000 WIRING DIAGRAM

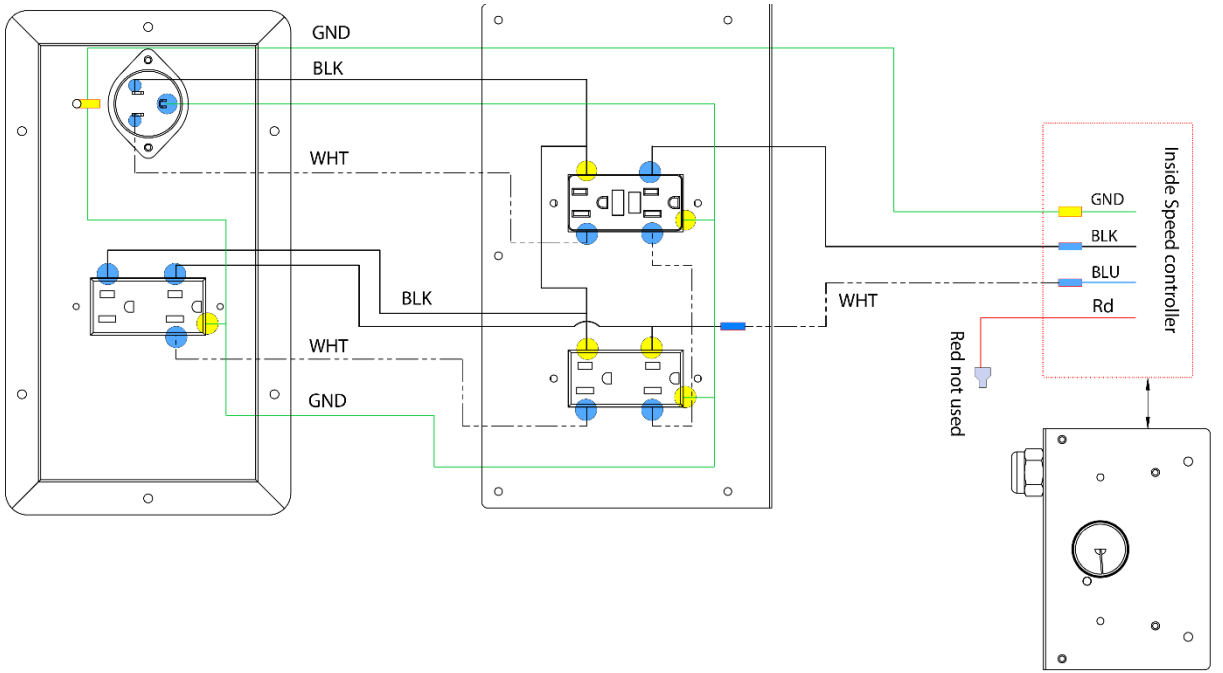

ITEM NO.	PART NUMBER	DESCRIPTION	QTY.
1	ELE12	STRAIN RELIEF	1
2	ELE14	GFCI Duplex Recepticle - Black Leviton	1
3	ELE140	Duplex Recepticle - Black Leviton 5325E	2
4	ELE04	15 Amp/125V Male Recep	1
7	Connector03	BSV14X-M Butt Connectors	3
8	Connector06	PN14-10FF-M #10 Post-Fork	11
9	Connector07	PV10-10RX-D Wire 12-10 Stud size #10 Yellow 500/box	2
10	Connector30	PN10-10FF-D Wire Size 12-10 Yellow 500/pk	6
11	Wire15	SAW3/14 Black 31" (requires modification from stock)	1
12	H5015	SPEED CONTROLLER 5 AMP @125 VAC	1
13	H5016	Knob For H5015/H5055 Speed Control	1

Starting Serial Number: C800019402727